



ø134 x H100 (mm)
Rth 0.67 °C/W
Power Pd 75 W

[MORE PRODUCT DETAILS](#)

ModuLED Mega-HBG High Bay LED Cooler ø134mm with driver connection system

Accessories

External driver box connection option



MechaTronix was formed in 2007, comprised of five already successful manufacturing companies, with each of them in excess of a decade of continuous operation. MechaTronix provides a wide variety of mechanical and electromechanical parts as well as assemblies for the international Original Equipment Manufacturers market.

Mounting indicator marks overview

The CoolBox driver box design keeps automatically the necessary space towards the LED cooler, so free air convection will not be blocked - no extra spacer needed.

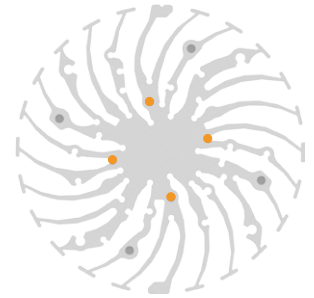

MechaTronix driver box

This universal driver box is designed in this way that almost all drivers available in the market up to 160 Watt can be mounted inside without the need of drilling or mechanical adaptations. The universal drivers clamping fixation also creates the perfect locking of your driver towards the top shell, so conduction can easily occur and convection towards the outside will guarantee the driver to keep within temperature specs.

Model Names

- CoolBox
Universal driver box for ModuLED and CoolBay® high bay LED coolers

Mounting

- Direct mounting on the LED cooler with 4 screws M5 x 10mm
Orange indicator marks

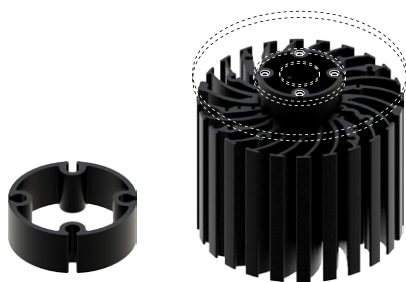

MechaTronix driver box connector ring

The driver box connector ring guarantees you the ideal space between the ModuLED LED cooler and your external driver box. With its open structure and aluminium conductivity, this is the ideal bridge between any driver box in the market and our high bay coolers.

Model Names

- Driver box connector ring

Mounting

- Direct mounting on the LED cooler with 4 screws M5 x 30mm
Orange indicator marks

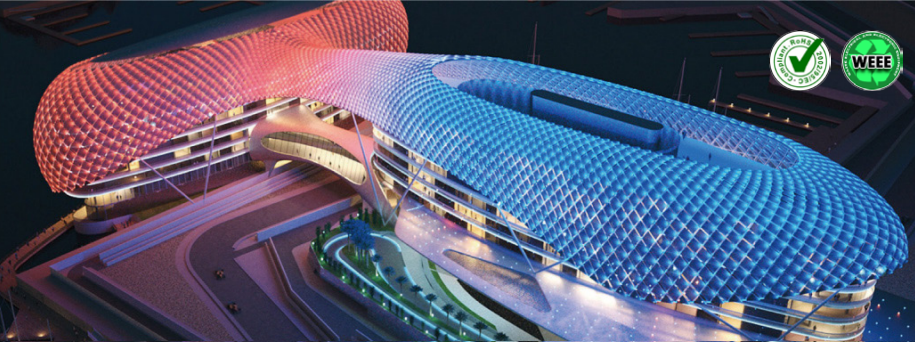

ø134 x H100 (mm)
Rth 0.67 °C/W
Power Pd 75 W

[MORE PRODUCT DETAILS](#)

ModuLED Mega-HBG High Bay LED Cooler ø134mm with driver connection system

Accessories

Lens & reflector connection



With regards to reflectors we have equipped our high bay with the most common high bay reflector standard, the 143mm pitch. For the lenses the standard mounting pattern is foreseen for all 100mm lenses with or without rubber gasket. Although we don't produce our own lenses and reflectors, we keep a limited number of models from stock available for your urgent needs. Below you can find an overview of these models as well as the mounting patterns which go along.

Mounting indicator marks overview

ModuLED Mega
Optics adaptor

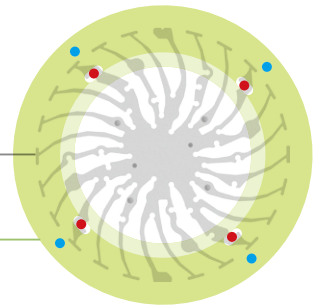

Adaptor plate for connection of reflector & lens

With the ModuLED Mega optics adaptor you get an unprecedented flexibility in choices of optics. Equipping your high bays with a wide variety of reflectors in metal or plastic, adding lenses for a controlled light image,... it all becomes plug-and-play.

Model Names

- ModuLED Mega optics adaptor v2

Mounting

- Direct mounting on the LED cooler with 4 MTX screws M5 x 6mm
Red indicator marks

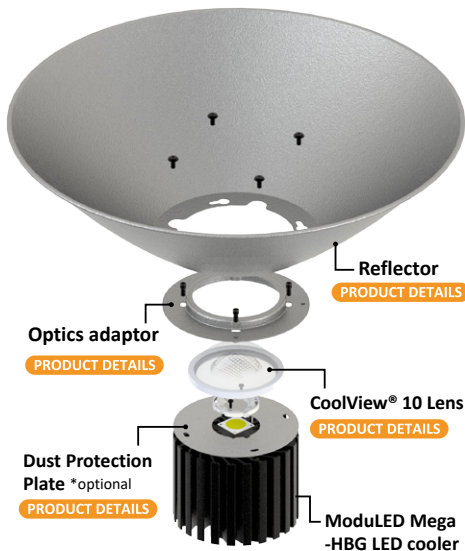

CoolView® 10 AG series Anti-Glare Lens

High end patented anti-glare lenses made out of borosilicate glass with beam angles 60°, 90° or 120°. Uniform light dispersion with high transparency 95% efficient borosilicate glass. Comes together with a high quality rubber gasket & metal frame (lens holder) - IP67 ingress protection against dust and moisture.

Model names

- CoolView® 10-60 AG
- CoolView® 10-90 AG
- CoolView® 10-120 AG

Mounting

- With Optics adaptor v2 + (4x) MTX screws M5 x 10mm
Red indicator marks

CoolBay® Reflector

A limited range of high-end off-the-shelf available high bay reflectors in high transfective coated aluminium or polycarbonate. All our reflectors follow the most common mounting standard with a pitch of 143mm and can be fixed with the ModuLED Mega optics adaptor towards the LED cooler. All our reflectors are transported in a special adapted packaging for damage prevention.

Model names

- CoolBay® Reflector 45
- CoolBay® Reflector 45 PC
- CoolBay® Reflector 90
- CoolBay® Reflector 120

Mounting

- Direct mounting on optics adaptor with 4 screws M5 x 6mm
Blue indicator marks

* To prevent dust accumulation in the lens or PC reflector cover through open structure of the ModuLED-HBG series cooling fins, please equip your lens with MechaTronix [Dust Protection Plate](#).

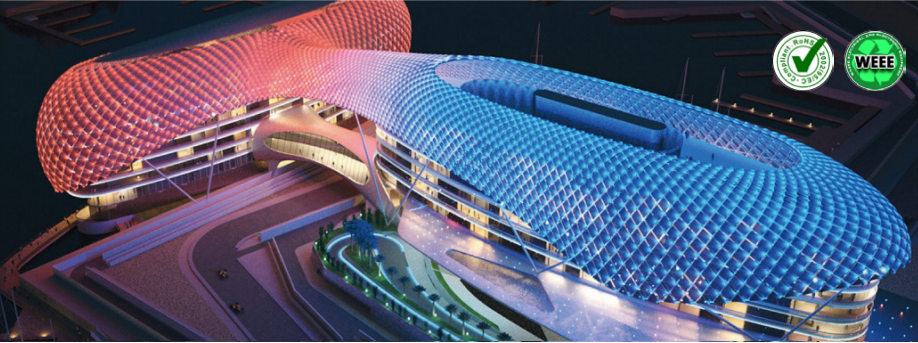

ø134 x H100 (mm)
Rth 0.67 °C/W
Power Pd 75 W

[MORE PRODUCT DETAILS](#)

ModuLED Mega-HBG High Bay LED Cooler ø134mm with driver connection system

Accessories

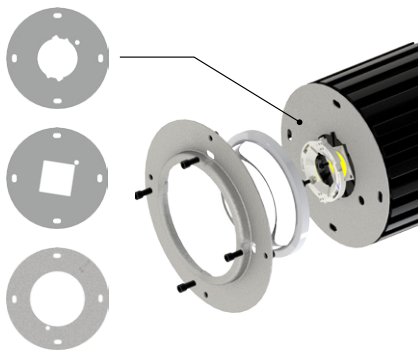

Dust Protection Plate

When you are using lenses on the ModuLED high bay coolers, the open structure of the cooling fins might lead to dust accumulation in the lens. To avoid this MechaTronix has developed a range of dust protection plates (DPP) which go along with various COB sizes and LED holders. This option is of course not needed when you equip your high bay with a non-cover reflector only.

Model Names

- DPP-Mega-2828-01
- DPP-Mega-2828-02
- DPP-Mega-3838-01
- DPP-Mega-3838-02
- DPP-Mega-ZHAGA3-01
- DPP-Mega-ZHAGA3-02
- DPP-Mega-BW458
- DPP-Mega-BW431

Mounting

- Mount in between the LED cooler & lens / reflector by use with optics adaptor
- 4 MTX screws M5 x 6mm
- Red indicator marks